

**PARTIAL SYNCHRONIZATION OF  
DIFFUSIVELY COUPLED CHUA SYSTEMS:  
AN EXPERIMENTAL CASE STUDY**

**R. v.d. Steen,\* H. Nijmeijer\***

*\* Department of Mechanical Engineering,  
Eindhoven University of Technology, P.O. box 513,  
5600 MB, Eindhoven, The Netherlands.  
R.v.d.Steen@student.tue.nl, H.Nijmeijer@tue.nl*

Abstract: In this paper partial synchronization of diffusively coupled Chua systems is presented. Partial synchronization is defined as the situation where some circuits synchronize with each other, while others do not. An experimental setup, consisting of maximal four Chua circuits operating in the double scroll regime, is used to show the existence of linear invariant manifolds corresponding to the partial synchronized state. *Copyright © 2006 IFAC*

Keywords: Synchronization, Electrical networks, Chaotic behavior, Network topology, Circuits

## 1. INTRODUCTION

Synchronization of coupled dynamical systems receives much attention in literature. One of the reasons for this is that synchronization can be found in several fields such as nature (Strogatz and Stewart, 1993), brain dynamics (Gray, 1994) and robotics (Nijmeijer and Rodrigues-Angeles, 2003). Also, the potential use of synchronization in communication and coordination forms a major reason for this interest. Recently partial synchronization in networks of identical systems is receiving particular interest. Some examples of partial synchronization can be found in (Hasler *et al.*, 1998; Zhang *et al.*, 2001; Pogromsky *et al.*, 2002).

Although there are many papers describing global synchronization of a network of coupled Chua circuits (Wu and Chua, 1995; Matías *et al.*, 1997; Sánchez *et al.*, 2000), less attention so far has been devoted to experimental results for bidirectional coupled systems. In this paper attention will be drawn to partial synchronization of Chua circuits. Partial synchronization is defined as the situation

where some circuits synchronize with each other, while others do not. It is shown that under certain conditions it is possible to obtain partial synchronization of diffusively coupled Chua circuits. An experimental setup consisting of four coupled Chua circuits is build to show the possibility of partial synchronization. The experimental results obtained qualitatively confirm simulation results. The remainder of this paper is organized as follows. In section 2 some preliminaries about the used notation are given. Further passive and convergent systems are described and the conditions for partial synchronization are stated. Section 3 deals with the experimental setup that is used. In section 4 and 5 synchronization of two and three diffusively coupled systems is shown, while in section 6 global and partial synchronization of four diffusively coupled systems is presented and discussed. Finally conclusions are drawn in section 7.

## 2. PRELEMINARIES

First a mathematical description for a network of coupled systems is introduced by adopting the notation used in (Pogromsky *et al.*, 2002). A general system description for  $k$  identical systems is given by

$$\dot{\mathbf{x}}_i = \mathbf{f}(\mathbf{x}_i) + \mathbf{B}\mathbf{u}_i, \quad \mathbf{y}_i = \mathbf{C}\mathbf{x}_i \quad (1)$$

where  $\mathbf{f}$  is a vector field,  $i = 1, \dots, k$ ,  $\mathbf{x}_i(t) \in \mathbb{R}^n$  is the state of the  $i$ th system,  $\mathbf{u}_i(t) \in \mathbb{R}^m$  and  $\mathbf{y}_i(t) \in \mathbb{R}^m$  are the input and output of the  $i$ th system, while  $\mathbf{B}$ ,  $\mathbf{C}$  are matrices of appropriate dimension.

The  $k$  systems are coupled through linear outputs

$$\mathbf{u}_i = -\gamma_{i1}(\mathbf{y}_i - \mathbf{y}_1) - \gamma_{i2}(\mathbf{y}_i - \mathbf{y}_2) - \dots - \gamma_{ik}(\mathbf{y}_i - \mathbf{y}_k). \quad (2)$$

By defining the symmetric  $k \times k$  matrix  $\mathbf{\Gamma}$  as

$$\mathbf{\Gamma} = \begin{pmatrix} \sum_{i=2}^k \gamma_{1i} & -\gamma_{12} & \dots & -\gamma_{1k} \\ -\gamma_{21} & \sum_{i=1, i \neq 2}^k \gamma_{2i} & \dots & -\gamma_{2k} \\ \vdots & \vdots & \ddots & \vdots \\ -\gamma_{k1} & -\gamma_{k2} & \dots & \sum_{i=1}^{k-1} \gamma_{ki} \end{pmatrix}, \quad (3)$$

the collection of  $k$  systems, with the matrix  $\mathbf{\Gamma}$  and feedback  $\mathbf{u}_i$ , can be rewritten as

$$\dot{\mathbf{x}} = \mathbf{F}(\mathbf{x}) + (\mathbf{I}_k \otimes \mathbf{B})\mathbf{u}, \quad \mathbf{y} = (\mathbf{I}_k \otimes \mathbf{C})\mathbf{x} \quad (4)$$

with the feedback

$$\mathbf{u} = -(\mathbf{\Gamma} \otimes \mathbf{I}_m)\mathbf{y} \quad (5)$$

where  $\mathbf{x} = \text{col}(\mathbf{x}_1, \dots, \mathbf{x}_k)$ ,  $\mathbf{F}(\mathbf{x}) = \text{col}(\mathbf{f}(\mathbf{x}_1), \dots, \mathbf{f}(\mathbf{x}_k)) \in \mathbb{R}^{kn}$ ,  $\mathbf{y} = \text{col}(\mathbf{y}_1, \dots, \mathbf{y}_k) \in \mathbb{R}^{km}$  and  $\mathbf{u} = \text{col}(\mathbf{u}_1, \dots, \mathbf{u}_k) \in \mathbb{R}^{km}$ . The notation  $\text{col}(\mathbf{x}_1, \dots, \mathbf{x}_k)$  stands for the column vector composed of the vectors  $\mathbf{x}_1, \dots, \mathbf{x}_k$ . The notation  $\otimes$  stands for the Kronecker product.

A system

$$\dot{\mathbf{x}} = \mathbf{f}(\mathbf{x}, \mathbf{u}), \quad \mathbf{y} = \mathbf{h}(\mathbf{x}) \quad (6)$$

is called passive, see (Willems, 1972), if the following inequality holds

$$\frac{d}{dt}V(\mathbf{x}) = \frac{\partial V(\mathbf{x})}{\partial \mathbf{x}} \mathbf{f}(\mathbf{x}, \mathbf{u}) \leq \mathbf{y}^T \mathbf{u} \quad (7)$$

where  $V(\mathbf{x})$  is a nonnegative function (storage function) defined on  $\mathbb{R}^n$ , for which  $V(0) = 0$ . If the dissipation inequality (7) is satisfied only for  $\mathbf{x}$  lying outside some ball

$$\dot{V}(\mathbf{x}, \mathbf{u}) \leq \mathbf{y}^T \mathbf{u} - H(\mathbf{x}) \quad (8)$$

where the function  $H : \mathbb{R}^n \rightarrow \mathbb{R}$  is nonnegative outside some ball

$$\exists \rho > 0, \quad |\mathbf{x}| \geq \rho \Rightarrow H(\mathbf{x}) \geq 0, \quad (9)$$

then the system is semipassive, see (Pogromsky *et al.*, 2002).

Consider a system

$$\dot{\mathbf{z}} = \mathbf{q}(\mathbf{z}, w(t)), \quad (10)$$

with  $\mathbf{z} \in \mathbb{R}^l$ , driven by an external signal  $w(t)$  taking values from a compact set. The system (10) is called convergent if for any bounded input  $w(t)$  the solution of (10) converges to a solution  $\mathbf{z}_w(t)$ , in other words, the solution of (10) will forget their specific initial condition. If there exists a positive definite symmetric  $l \times l$  matrix  $\mathbf{P}$  such that all eigenvalues  $\lambda_i(\mathbf{Q})$  of the symmetric matrix

$$\mathbf{Q}(\mathbf{z}, w) = \frac{1}{2} \left[ \mathbf{P} \left( \frac{\partial \mathbf{q}}{\partial \mathbf{z}}(\mathbf{z}, w) \right) + \left( \frac{\partial \mathbf{q}}{\partial \mathbf{z}}(\mathbf{z}, w) \right)^T \mathbf{P} \right] \quad (11)$$

are negative and separated from zero, such that

$$\lambda_i(\mathbf{Q}(\mathbf{z}, w)) \leq \epsilon < 0, \quad (12)$$

with  $\epsilon > 0$  and  $i = 1 \dots l$  for all  $\mathbf{z}, w \in \mathbb{R}^l$ , then system (10) is convergent, cf (Pavlov *et al.*, 2004).

If the network contains repeating patterns, the permutation of some elements of  $\mathbf{\Gamma}$  leave the network invariant. Such a permutation matrix  $\mathbf{\Pi}$  is a symmetry for the network if  $\mathbf{\Pi}$  commutes with  $\mathbf{\Gamma}$ , i.e.  $\mathbf{\Pi}\mathbf{\Gamma} - \mathbf{\Gamma}\mathbf{\Pi} = 0$ . A permutation matrix  $\mathbf{\Pi}$  commuting with  $\mathbf{\Gamma}$  defines a linear invariant manifold of the closed loop system (4) and (5) as

$$\ker(\mathbf{I}_{kn} - \mathbf{\Pi} \otimes \mathbf{I}_n). \quad (13)$$

The stability of such manifolds depends on the asymptotic stability of sets. Due to converse Lyapunov theorem, e.g. (Lin *et al.*, 1996), the asymptotic stability of a set is equivalent to the existence of a scalar storage function  $V$ , which is zero only on the set and decays along the trajectories otherwise. In the context of the coupled systems (1, 2) a Lyapunov function should be found as a sum of two functions. The first function depends on the input-output relations of the systems (1), while the second function depends on the interacting due to the coupling of systems.

Under the assumption that the matrix  $\mathbf{C}\mathbf{B}$  is nonsingular (and positive definite) a linear coordinate transformation  $\mathbf{x}_i \rightarrow (\mathbf{y}_i, \mathbf{z}_i)$  exists such that

$$\dot{\mathbf{z}}_i = \mathbf{q}(\mathbf{z}_i, \mathbf{y}_i), \quad \dot{\mathbf{y}}_i = \mathbf{g}(\mathbf{z}_i, \mathbf{y}_i) + \mathbf{C}\mathbf{B}\mathbf{u}_i, \quad (14)$$

where  $\mathbf{z}_i \in \mathbb{R}^{n-m}$  and  $\mathbf{q}$  and  $\mathbf{g}$  are vector functions. Then the stability of the manifolds given by (13) is determined by the following theorem.

**Theorem 1** (Pogromsky *et al.*, 2002). Let  $\lambda'$  be the minimal eigenvalue of  $\mathbf{\Gamma}$  under restriction that the eigenvectors of  $\mathbf{\Gamma}$  are taken from the set  $\text{range}(\mathbf{I}_k - \mathbf{\Pi})$ . Suppose that:

1. Each individual system (1) is strictly semipassive with respect to the input  $\mathbf{u}_i$  and output

$\mathbf{y}_i$  with a radially unbounded storage function  $V(\mathbf{x}_i, \mathbf{u}_i)$ .

2. There exists a positive definite matrix  $\mathbf{P}$  such that inequality (12) holds for some  $\epsilon > 0$  for the matrix  $\mathbf{Q}$  defined as in (11) for  $\mathbf{q}$  as in (14).

Then all solutions of the diffusive cellular network (4) and (5) are ultimately bounded and there exists a positive  $\bar{\lambda}$  such that if  $\lambda' > \bar{\lambda}$  the set  $\ker(\mathbf{I}_{kn} - \mathbf{\Pi} \otimes \mathbf{I}_n)$  contains a globally asymptotically stable compact subset.

### 3. SETUP

An experimental setup consisting of a network of 4 Chua circuits is used, shown in figure 1. Consider

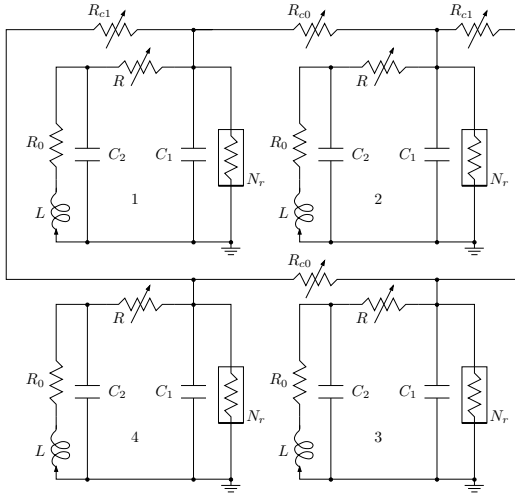

Fig. 1. Schematic layout of four symmetrically coupled Chua circuits.

the well known system description of a single Chua circuit (Matsumoto, 1985)

$$\begin{aligned} C_1 \dot{x}_{i1} &= G(x_{i2} - x_{i1}) - f(x_{i1}) \\ C_2 \dot{x}_{i2} &= G(x_{i1} - x_{i2}) + x_{i3} \\ L \dot{x}_{i3} &= -x_{i2} - R_0 x_{i3} \end{aligned} \quad (15)$$

with  $G = \frac{1}{R}$  and the function  $f(x_{i1})$  defined as

$$G_b x_{i1} + \frac{1}{2}(G_a - G_b)(|x_{i1} + B_p| - |x_{i1} - B_p|). \quad (16)$$

In these equations the variables  $x_{i1}$  and  $x_{i2}$  are the voltages across the capacitors,  $C_1$  and  $C_2$ ,  $x_{i3}$  is the current flowing through the inductor  $L$ , which has an internal resistance  $R_0$ .  $G_a$  and  $G_b$  are the conductances of the piecewise characteristic for  $|x_{i1}| < B_p$  and  $|x_{i1}| \geq B_p$  respectively.  $B_p$  is voltage of the breakpoint. Measurements of  $x_{i1}$  and  $x_{i2}$  are available. For the coupling between systems the matrices  $\mathbf{B}$  and  $\mathbf{C}$  are as follows

$$\mathbf{B} = [1 \ 0 \ 0]^T \quad \mathbf{C} = [1 \ 0 \ 0]. \quad (17)$$

The coupling strength between systems is controlled by four variable resistors. The nonlinear resistor,  $N_r$ , in the circuits is build with

operational amplifiers (AD712JN) as described in (Kennedy, 1992). The nominal values of the components can be found in table 1, however due to tolerances of the components each circuit is slightly different. Therefore synchronization in the sense that  $|\mathbf{x}_i(t) - \mathbf{x}_j(t)| = 0$  is not possible and practical synchronization is defined as  $|\mathbf{x}_i(t) - \mathbf{x}_j(t)| \leq \delta$ , for some fixed  $\delta > 0$ .

Table 1. Nominal values for each circuit.

Component	Value
$C_1$	10 [nF]
$C_2$	100 [nF]
$L$	22 [mH]
$R_0$	22 [ $\Omega$ ]
$R$	1.5-2.0 [k $\Omega$ ]
$G_a$	-0.758 [mS]
$G_b$	-0.409 [mS]
$B_p$	1.75 [V]

### 4. TWO SYSTEMS

Before synchronization of four systems is considered, the threshold value for synchronization of two circuits is determined, i.e., the minimal value  $K$  such that practical synchronization occurs. The two circuits are diffusely coupled with a variable resistor,  $R_c$ , which gives the coupling constant  $K$  as  $\frac{1}{R_c}$  and a coupling matrix

$$\mathbf{\Gamma}_1 = \begin{bmatrix} K & -K \\ -K & K \end{bmatrix}. \quad (18)$$

The variable resistor  $R$  is set to 1775 [ $\Omega$ ] on both circuits, so the circuits operate on the double scroll attractor. Synchronization is visualized by the phase portrait of  $x_{11}$  and  $x_{21}$ , shown in figure 2(b). The value of  $R_c$  for the synchronization threshold is around 3400 [ $\Omega$ ] with  $\delta = 0.15$  [V].

Remark: If the value  $R_c$  is increased, desynchronization occurs and at about  $R_c = 10$  [k $\Omega$ ] the trajectories are no longer bounded. A possible explanation for this phenomena is the following. A single circuit (15), with  $\mathbf{u} = 0$ , can have unbounded trajectories. No storage function  $V(\mathbf{x})$  can be found such that inequality (8) is satisfied to prove semipassivity for system (15). Therefore it is not guaranteed that the solutions are ultimately bounded. This may cause the bursting phenomenon above 10 [k $\Omega$ ]. For  $R_c = 30$  [k $\Omega$ ] and above the current through the coupling resistor becomes negligible such that both circuits operate as free systems and the trajectories of both are bounded by their attractors again.

### 5. THREE SYSTEMS

When the network is expanded by adding a circuit, see figure 3, the following coupling matrix  $\mathbf{\Gamma}$  is obtained

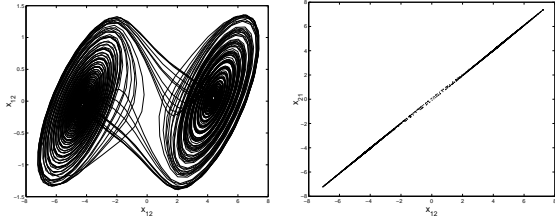

(a) Projection of  $x_{12}$  versus  $x_{11}$ . (b) Phase portrait of  $x_{21}$  versus  $x_{11}$ .

Fig. 2. Experimental synchronization for  $R_c = 3430$  [ $\Omega$ ].

$$\mathbf{\Gamma}_2 = \begin{bmatrix} 2K & -K & -K \\ -K & 2K & -K \\ -K & -K & 2K \end{bmatrix}. \quad (19)$$

The coupling constant needed to globally syn-

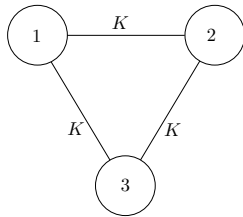

Fig. 3. Layout of three coupled systems.

chronize this structure can be estimated using the conjecture stated in (Wu and Chua, 1996):

$$\mu_1 \alpha_1 = \mu_2 \alpha_2 \quad (20)$$

where  $\mu_i$ ,  $i = 1, 2$  is the smallest nonzero eigenvalue of the coupling matrix  $\mathbf{\Gamma}_i$  and  $\alpha_i$  the coupling coefficient. Although it has been pointed out in (Pecora, 1998) that this conjecture is in general wrong, it holds in this particular case.

The synchronization threshold for three systems, using (20), requires a resistor value of 5100 [ $\Omega$ ]. The threshold value in experiments is found to be 4950 [ $\Omega$ ], confirming that three systems, coupled in a ring structure, synchronize with a lower coupling constant  $K$ .

## 6. FOUR SYSTEMS

Four systems are symmetrically coupled in a ring structure with two coupling constants  $K_0$  and  $K_1$ . With the proposed coupling, as shown in figure 4,

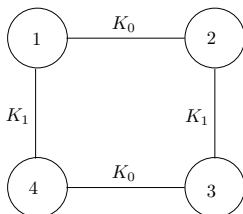

Fig. 4. Layout of four coupled systems.

the coupling matrix  $\mathbf{\Gamma}$  can be written as follows

$$\mathbf{\Gamma}_3 = \begin{bmatrix} K_0 + K_1 & -K_0 & 0 & -K_1 \\ -K_0 & K_0 + K_1 & -K_1 & 0 \\ 0 & -K_1 & K_0 + K_1 & -K_0 \\ -K_1 & 0 & -K_0 & K_0 + K_1 \end{bmatrix} \quad (21)$$

If  $K_0 = K_1 = K$  the smallest nonzero eigenvalue of  $\mathbf{\Gamma}_3$ ,  $\mu_3$ , is equal to the smallest eigenvalue of  $\mathbf{\Gamma}_1$ , and the ring structure should synchronize with  $R_c$  around 3400 [ $\Omega$ ]. In figure 5 global synchronization is shown for  $R_c = 3200$  [ $\Omega$ ] again with  $\delta = 0.15$  [ $V$ ].

With the symmetric coupling matrix (21) there are four permutation matrices  $\mathbf{\Pi}$  commuting with  $\mathbf{\Gamma}_3$

$$\begin{aligned} \mathbf{\Pi}_1 &= \begin{bmatrix} \mathbf{A} & \mathbf{O} \\ \mathbf{O} & \mathbf{A} \end{bmatrix}, & \mathbf{\Pi}_2 &= \begin{bmatrix} \mathbf{O} & \mathbf{I}_2 \\ \mathbf{I}_2 & \mathbf{O} \end{bmatrix} \\ \mathbf{\Pi}_3 &= \begin{bmatrix} \mathbf{O} & \mathbf{A} \\ \mathbf{A} & \mathbf{O} \end{bmatrix}, & \mathbf{\Pi}_4 &= \mathbf{I}_4 \end{aligned} \quad (22)$$

where

$$\mathbf{A} = \begin{bmatrix} 0 & 1 \\ 1 & 0 \end{bmatrix}, \quad \mathbf{O} = \begin{bmatrix} 0 & 0 \\ 0 & 0 \end{bmatrix}. \quad (23)$$

Three linear invariant manifolds associated with (22) exist independently of systems (1) and are given by

$$\mathcal{A}_1 = \mathbf{x} \in \mathbb{R}^{4n} : \mathbf{x}_1 = \mathbf{x}_2, \mathbf{x}_3 = \mathbf{x}_4 \quad (24)$$

$$\mathcal{A}_2 = \mathbf{x} \in \mathbb{R}^{4n} : \mathbf{x}_1 = \mathbf{x}_3, \mathbf{x}_2 = \mathbf{x}_4 \quad (25)$$

$$\mathcal{A}_3 = \mathbf{x} \in \mathbb{R}^{4n} : \mathbf{x}_1 = \mathbf{x}_4, \mathbf{x}_2 = \mathbf{x}_3. \quad (26)$$

The intersection of any two of these manifolds describes the full synchronization manifold ( $\mathbf{x}_1 = \mathbf{x}_2 = \mathbf{x}_3 = \mathbf{x}_4$ ). There are two possible ways to global synchronization depending on the ratio  $K_0$  and  $K_1$

$$\mathcal{A}_1 \rightarrow \mathcal{A}_1 \cap \mathcal{A}_2 \quad (27)$$

$$\mathcal{A}_3 \rightarrow \mathcal{A}_3 \cap \mathcal{A}_2. \quad (28)$$

Theorem 1, to prove stability of these manifolds, depends on two conditions. It is already pointed out that the first condition is not satisfied, since system (15) is not semipassive. However on an experimental setup the solutions are normally bounded by the attractor.

With  $x_1$  chosen as the external signal in (14) and  $\mathbf{z} = [x_2 \ x_3]^T$  and the parameter values in table 1, it is possible to find a matrix  $\mathbf{P}$  such that (12) is satisfied and therefore system (15) is convergent. Hence it is expected that these manifolds are locally stable on the Chua circuits as long as the solutions remain bounded by the attractor. This is confirmed as shown in figures 6 and 7. In figure 6 it can be seen that the circuits one and two and also three and four are synchronized with a coupling constant  $K_0 = \frac{1}{R_{c0}}$ . Circuits two

and three, coupled with  $K_1 = \frac{1}{R_{c1}}$ , are, as well as one and four, not synchronized. This corresponds to manifold  $\mathcal{A}_1$  (24). In figure 7 the situation corresponding to manifold  $\mathcal{A}_3$  (26) is depicted. These manifolds are robust to parameter variation of the variable resistors  $R$  of the circuits. However if the coupling resistances are increased the same phenomena with two coupled systems occurs, i.e., the trajectories are no longer bounded. And again above a second threshold the four circuits operate as free systems. All these phenomena are summarized in a stability diagram shown in figure 8.

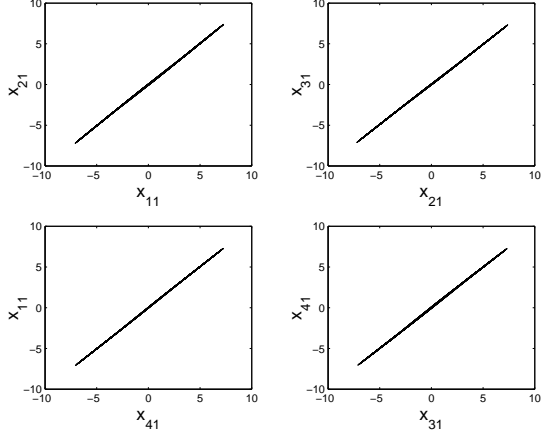

Fig. 5. Phase portraits for global synchronization with  $R_{c0} = R_{c1} = 3200$  [ $\Omega$ ].

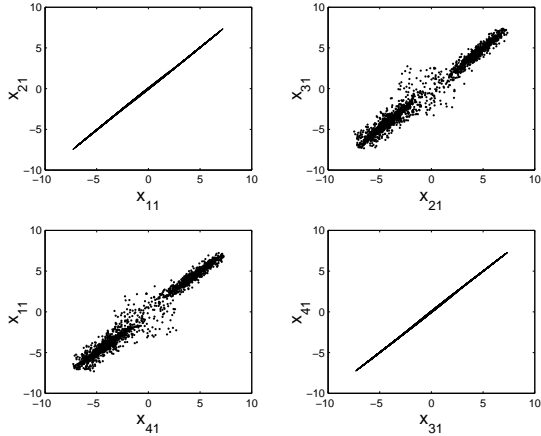

Fig. 6. Phase portraits for partial synchronization with  $R_{c0} = 3200$  and  $R_{c1} = 9300$ .

This stability diagram can also be obtained by numerically integrating four Chua systems (15), taking the tolerances of the components into account. The presented experimental results are qualitative comparable with numerical simulations. As an illustrative numerical example partial synchronization is considered. For the individual systems the capacitors and variable resistor are chosen as in table 2, while the other parameters of system (15) are the same as in table 1. The coupling constants  $K_0$  and  $K_1$  are  $\frac{1}{8500}$  and  $\frac{1}{3200}$  respectively. In figure 9 the error signals  $x_{i1} - x_{j1}$ ,  $i, j = 1, 2, 3, 4$  are

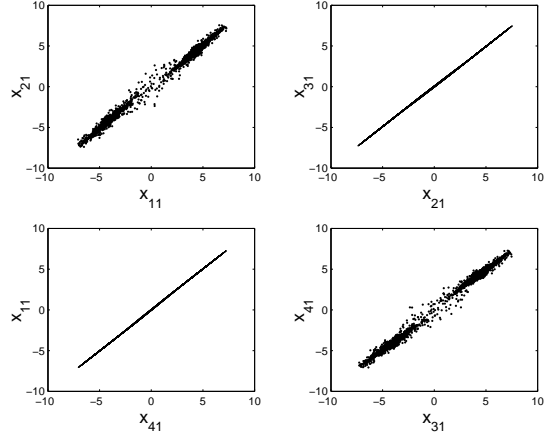

Fig. 7. Phase portraits for partial synchronization with  $R_{c0} = 9300$  and  $R_{c1} = 3200$ .

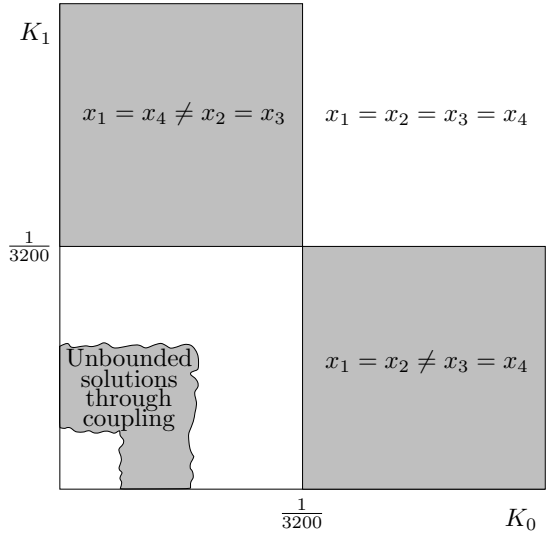

Fig. 8. Stability diagram.

shown. After the transients are vanished systems two and three synchronize as well as one and four. This simulation result matches with the experimental partial synchronization as shown in figure 7.

Table 2. Parameter values for individual circuits.

System	Component	Value
1	$C_1$	10.90 [nF]
	$C_2$	97.93 [nF]
	$R$	1775 [ $\Omega$ ]
2	$C_1$	10.80 [nF]
	$C_2$	99.60 [nF]
	$R$	1778 [ $\Omega$ ]
3	$C_1$	10.98 [nF]
	$C_2$	101.90 [nF]
	$R$	1770 [ $\Omega$ ]
4	$C_1$	10.65 [nF]
	$C_2$	100.50 [nF]
	$R$	1780 [ $\Omega$ ]

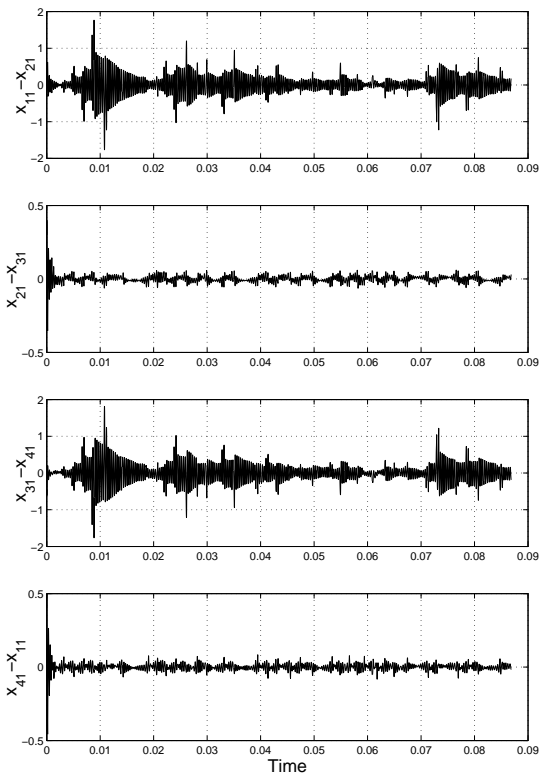

Fig. 9. Simulation synchronization errors for  $R_{c0} = 8500$  and  $R_{c1} = 3200$ .

## 7. CONCLUSIONS

In this paper experimental partial synchronization of diffusively coupled Chua circuits is presented. With the experimental setup it is impossible to achieve a zero synchronization error due to tolerances of the electrical components. Therefore a form of practical synchronization is introduced to be able to specify synchronization of two systems. Besides global synchronization of two circuits, a bursting phenomena is observed if the diffusive coupling between two systems is above a certain threshold value. At this point the trajectories are no longer bounded by the double scroll attractor. In the case where four circuits are symmetrically coupled it shown that partial synchronization is possible. The stability of the linear invariant manifolds, describing this partial synchronization, can not be proven globally. However the manifolds are locally stable if the solutions remain bounded by the double scroll attractors.

## REFERENCES

Gray, C.M. (1994). Synchronous oscillations in neuronal systems: mechanisms and functions. *J. Comput. Neurosci.* **1**, 11–38.

Hasler, M., Y. Maistrenko and O. Popovych (1998). Simple example of partial synchronization of chaotic systems. *Phys. Rev. E* **58**(5), 6843–6846.

Kennedy, M.P. (1992). Robust Op Amp realization of Chua’s circuit. *Frequenz* **46**(3-4), 66–80.

Lin, Y., E.D. Sontag and Y. Wang (1996). A smooth converse lyapunov theorem for robust stability. *SIAM J. Control Opt.* **34**, 124–160.

Matías, M.A., V. Pérez-Muñuzuri, M.N. Lorenzo, I.P. Mariño and V. Pérez-Villar (1997). Observation of a fast rotating wave in rings of coupled chaotic oscillators. *Phys. Rev. Lett.* **78**(2), 219–222.

Matsumoto, T. (1985). A chaotic attractor from Chua’s circuit. *IEEE Trans. Circ. Syst.* **31**(12), 1055–1058.

Nijmeijer, H. and A. Rodrigues-Angelas (2003). *Synchronization of mechanical systems*. World Scientific Publishing Co. London.

Pavlov, A., A. Pogromsky, N. van de Wouw and H. Nijmeijer (2004). Convergent dynamics, a tribute to Boris Pavlovich Demidovich. *Sys. Cont. Lett.* **52**, 257–261.

Pecora, L.M. (1998). Synchronization conditions and desynchronization patterns in coupled limit-cycle and chaotic systems. *Phys. Rev. E* **58**(1), 347–360.

Pogromsky, A., G. Santoboni and H. Nijmeijer (2002). Partial synchronization: from symmetry towards stability. *Physica D* **172**, 65–87.

Sánchez, E., M.A. Matías and V. Pérez-Muñuzuri (2000). Chaotic synchronization in small assemblies of driven Chua’s circuits. *IEEE Trans. Circ. Syst.* **47**(5), 644–654.

Strogatz, S.H. and I. Stewart (1993). Coupled oscillators and biological synchronization. *Sci. Am.* **269**, 102–109.

Willems, J.C. (1972). Dissipative Dynamical Systems Part I: General Theory. *Arch. Rational. Mech. Anal.* **45**, 321–351.

Wu, C.W. and L.O. Chua (1995). Synchronization in an array of linearly coupled dynamical systems. *IEEE Trans. Circ. Syst.* **42**(8), 430–447.

Wu, C.W. and L.O. Chua (1996). On a conjecture regarding the synchronization in an array of linearly coupled dynamical systems. *IEEE Trans. Circ. Syst.* **43**(2), 161–165.

Zhang, Y., G. Hu, H.A. Cerdeira, S. Chen, T. Braun and Y. Yao (2001). Partial synchronization and spontaneous spatial ordering in coupled chaotic systems. *Phys. Rev. E* **63**, 026211.